

EFFECT · Kettle 500L



POWER

57 kW

DIMENSIONS

1889×1100×2250 mm

CAPACITY

500 L

WEIGHT

460 kg

Why NORQi Kettle?

- Fast heating 20–200°C
- Digital touch panel with precise 1-degree control
- Gentle simmering function for delicate ingredients
- Tilt height 400 mm — compact and ergonomic
- Automatic water filling
- Energy-efficient heating with heating elements

Technical specifications

Article number	700500
Capacity (L)	500 L
Voltage (V)	3×400V+N+PE
Frequency (Hz)	50/60
Power (kW)	57 kW
Current L1/L2/L3 (A)	L1: 95 A / L2: 95 A / L3: 95 A
Noise level (dBa)	<70
Regulation	Digital touch panel
IP class	IP X5
Weight (kg)	460 kg

Dimension drawing

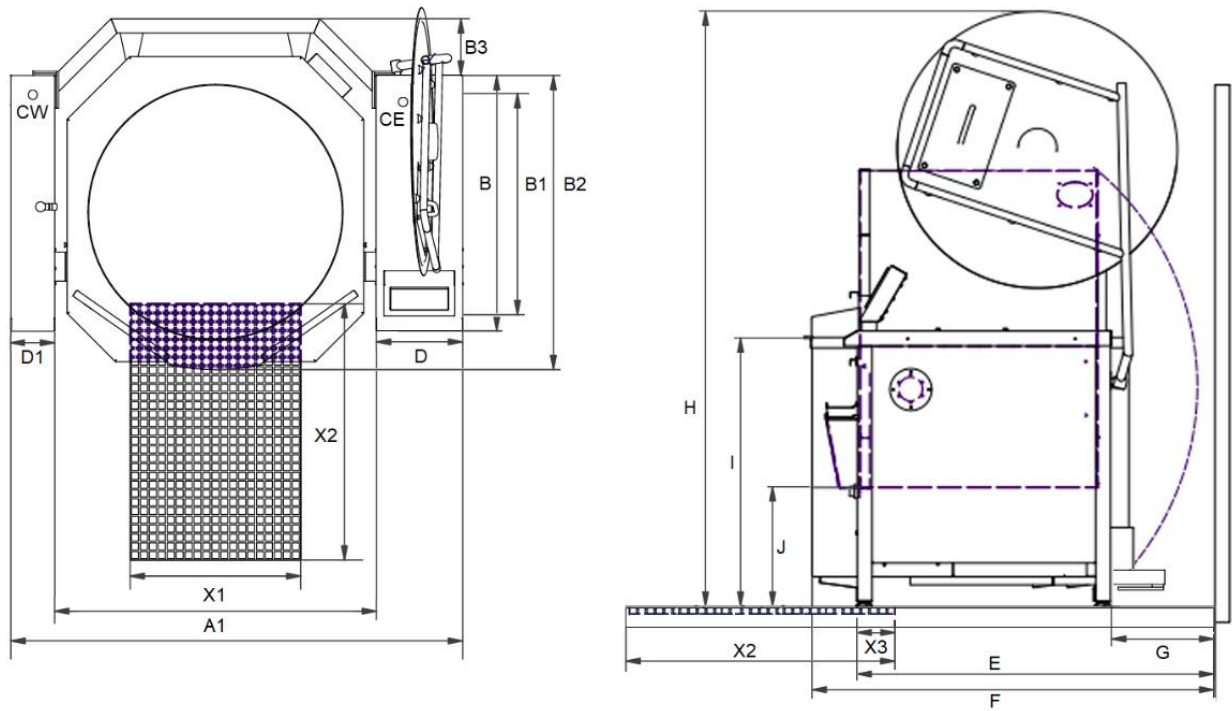

All dimensions in mm

Dim	mm
A	1889
A1	1239
B	850
B1	750
B2	1100
B3	—
D	400
D1	250
G	—

Dim	mm
H	2250
I	900
J	400
X1	600
X2	900
X3	100
E	—
F	—

Accessories

- Extra support / 2 kettles on one pillar
- Funnel for inspection port
- Tool trolley for 2 kettles
- Measuring rod 75L
- Measuring rod 100L
- Measuring rod 125L
- Measuring rod 150L
- Measuring rod 200L
- Measuring rod 250L

Detailed accessory information available at norqi.dk

Accessories

- Measuring rod 300L
- Measuring rod 400L
- Measuring rod 500L
- 230V power outlet Schuko
- 230V power outlet CEE
- Pouring plate 500L
- Water gun (2 metre hose)
- LED light on lid
- Canteen holder / GN shelf
- 2" butterfly valve
- Strainer plate 500L
- 3" butterfly valve
- 2" ball valve
- 3" ball valve
- 230V power outlet with splash guard
- Marine voltage 3x400V+PE
- Castors for kettle (max. 200L), 4 pcs.
- Floor enclosure — BASIC kettle
- Air curtain for kettle
- Floor mounting kit

Detailed accessory information available at norqi.dk